

User Interface diagram 1 (ver.0.0 ed.16)

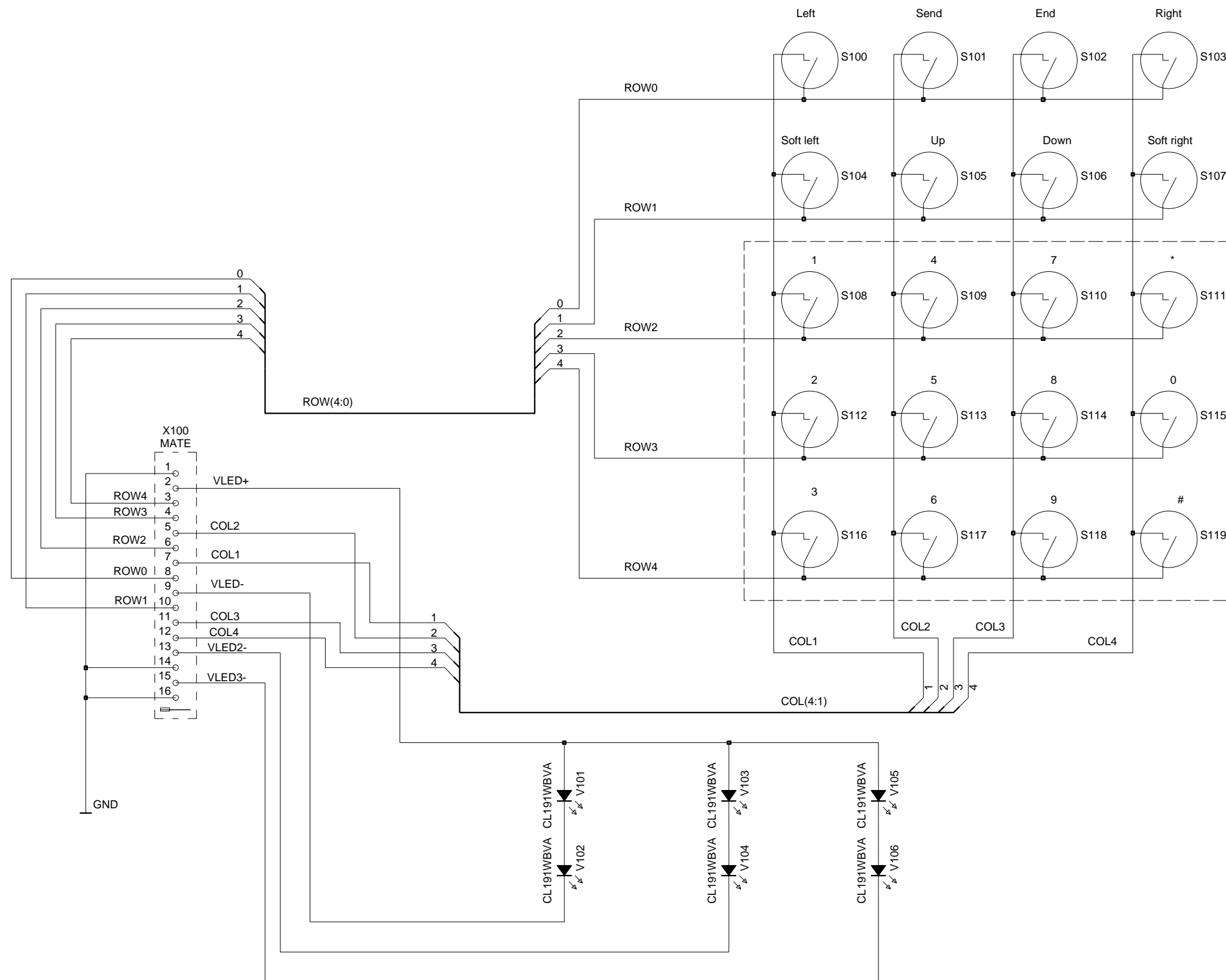

These have different geometry

E101, E102 ARE 1.2 MM  
E103 ARE 2.0 MM

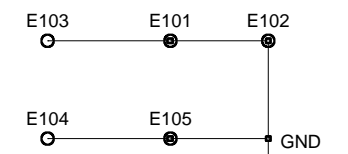

E104, E105 ARE 2.0 MM

Parts Placement diagram

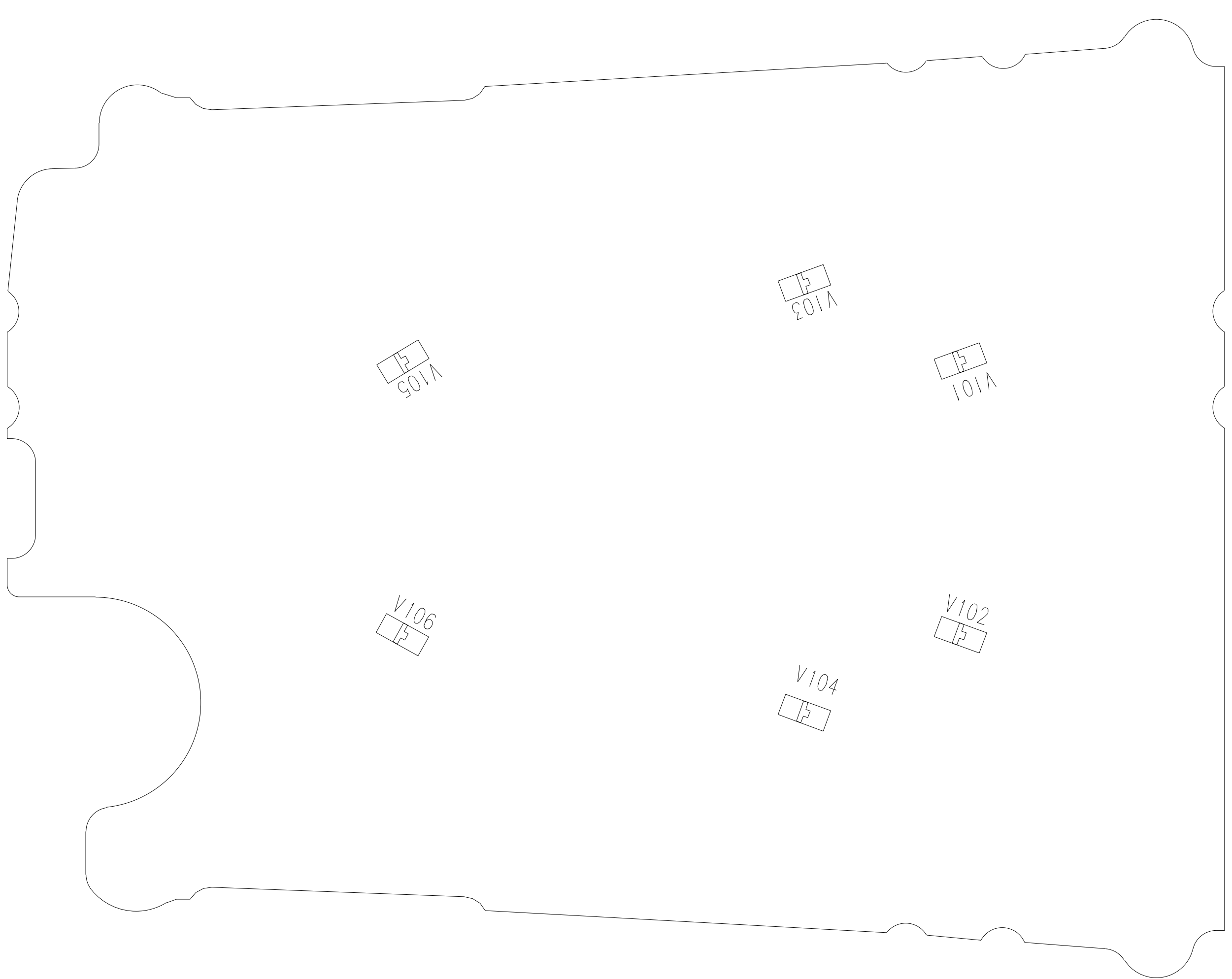

fk4\_12a\_asmdrw\_t.pdf, AUTOSCALE